



**kaivac cleaning systems™**

*Complete Cleaning For Healthy Results™*

## Warranty Registration Form

Free gift with completion of form

To be completed and mailed or faxed by the customer purchasing equipment.  
Return this warranty card within ten days of purchase.

Purchased By:

Name \_\_\_\_\_ Title \_\_\_\_\_

Company \_\_\_\_\_

Street Address \_\_\_\_\_

City \_\_\_\_\_ State \_\_\_\_\_ Zip Code \_\_\_\_\_

Phone Number \_\_\_\_\_ Fax \_\_\_\_\_

Date Purchased \_\_\_\_\_ Name of Distributor \_\_\_\_\_

KaiVac®                       KaiZen™  
Serial Number \_\_\_\_\_

Does your system include a KaiTutor™?     Yes     No

### Type of Business

- |   |                                      |
|---|--------------------------------------|
| <input type="checkbox"/> School/University    | <input type="checkbox"/> Industrial  |
| <input type="checkbox"/> Hospital/Health Care | <input type="checkbox"/> Office      |
| <input type="checkbox"/> Contract Cleaner     | <input type="checkbox"/> Other _____ |

### Intended Uses (check all that apply):

- |  |  |   |
|--|--|---|
| <input type="checkbox"/> Restroom Cleaning | <input type="checkbox"/> Cleaning Around Machinery | <input type="checkbox"/> Classroom Cleaning |
| <input type="checkbox"/> Floor Stripping   | <input type="checkbox"/> Stairwell Cleaning        | <input type="checkbox"/> Other _____        |
| <input type="checkbox"/> Kitchen Cleaning  | <input type="checkbox"/> Locker and Shower Room    |   |
| <input type="checkbox"/> Carpet Extraction | <input type="checkbox"/> Hallway Cleaning          |   |

Thank you very much for the information you have filled out for our records. As our way of saying thank you, we'd like to send you a free Microfiber KaiTowel.

Kaivac, Inc. · 401 South Third St. · Hamilton, Ohio 45011  
Phone (513) 887-4600 · Fax (513) 887-4601 · Toll Free (800) 287-1136 · www.kaivac.com

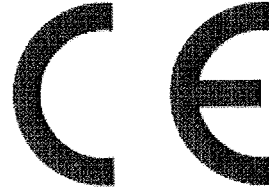

## Certificate of Conformity

We **Kaivac, Inc.**  
**401 S. Third Street**  
**Hamilton, OH 45011 USA**

Declare and Certify that the following product

Machine	
Type/Model	
Serial Number	
Date of Manufacture	

Has been manufactured using the following standards and specifications;  
And has been inspected and tested at our works in accordance with the relative specifications and drawings with which they comply in all respects;  
And has been affixed with the CE Mark in Compliance with the following standards and specifications:

- BS EN 292-1:1991 Safety of Machinery - Basic concepts, general principles for design. Part 1: Basic terminology, methodology.*
- BS EN 292-2:1991 Safety of Machinery - Basic concepts, general principles of design - Part 2: Technical principles and specifications.*
- BS EN 614-1:1995 Safety of Machinery - Ergonomic design principles - Part 1: Terminology and general principles.*
- BS EN 1050:1996 Safety of Machinery - Principles for risk assessment*
- BS EN 60204-1:1993 Safety of Machinery - Electrical equipment of machines - Part 1: Specification for general requirements.*

and complies with the requirements of:

*European Machinery directive 98/37/EC*  
*UK Regulation 1992 no. 3073 - Supply of Machinery (Safety) Regulations 1992, and as amended.*

*European Low Voltage Directive 73/23/EC and as amended by 93/68/EC.*  
*UK Regulation 1994 no.3260 - Electrical Equipment (Safety) Regulations 1994.*

Place of Issue	401 S. Third Street, Hamilton, OH 45011 USA
Date of Issue	
Signature	
Printed Name	
Position	Quality Manager

# Filter Screen Cleaning Procedure

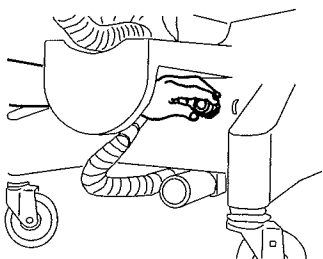

KaiVac filter is located on the base below the vac hose wrap on front of machine.

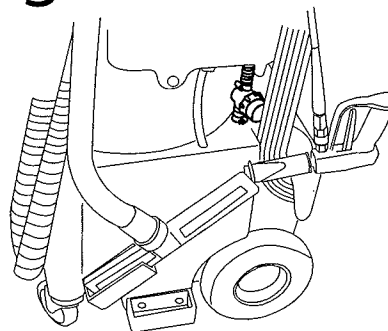

KaiZen filter is located on the left side of machine between water supply tank and the hood assembly.

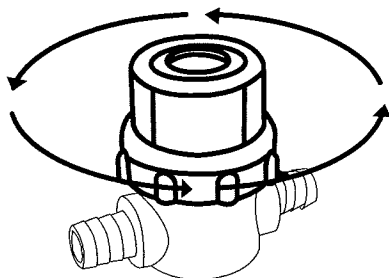

Rotate bowl cover counterclockwise to remove.

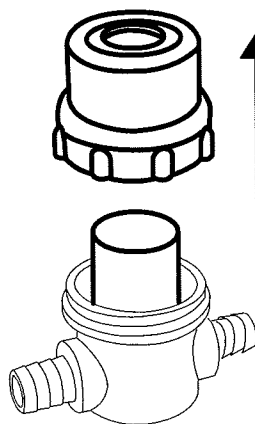

Lift bowl cover up and remove.

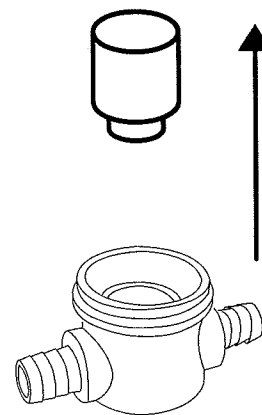

Pull filter up and out.

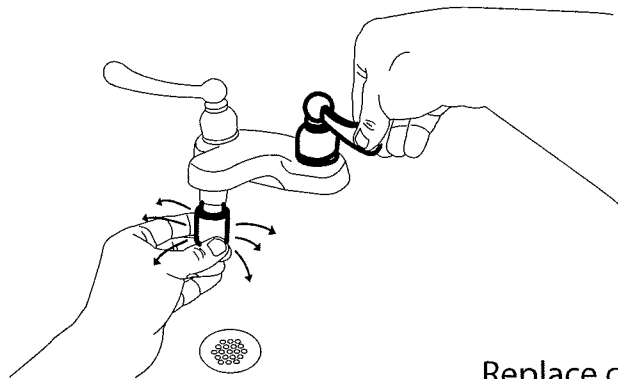

Place filter screen with the open end up against spout of sink fixture or water source and turn on the water flushing debris from the inside out. Continue flushing until water flows freely thru filter. Filter is clean if one can blow freely thru it.

Replace cleaned filter reversing the procedure above. If filter cannot be cleaned replace with new one.

**DO NOT OPERATE MACHINE WITHOUT FILTER.**

# Winterize your Kaivac Equipment

Your Kaivac machinery should be winterized between uses if it is to be exposed to freezing temperatures. To winterize your machine, pour 1/2 gallon of windshield wiper fluid into the empty water tank. Aim the spray gun into the water tank. Run the pump and spray the gun until the fluid begins running through.



# KaiVac Operator's Manual

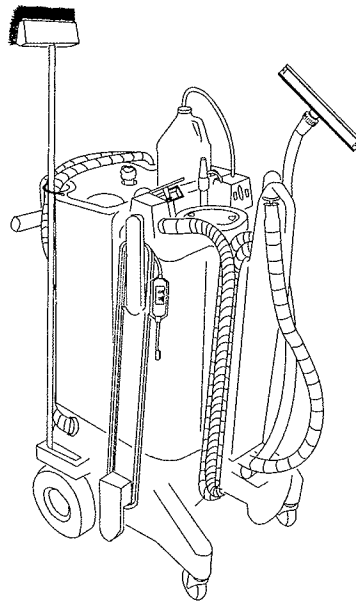

Serial Number:

---

Date of Purchase:

---

Source of Purchase (Distributor):

---

KaiVac Incorporated  
401 South Third Street  
Hamilton, Ohio 45011  
phone: 800-287-1136  
fax: 513-887-4601  
kaivac.com

READ THIS MANUAL CAREFULLY BEFORE OPERATING THE KAIKAC  
CLEANING SYSTEM

# TABLE OF CONTENTS

## SECTION 1

1.....	Introduction
2-3.....	Safety Precautions
4.....	Limited Warranty Protection Plan
5-16.....	S.I.M.P.L.E Operation
17.....	Optional Uses
18.....	Chemical Injection Chart
19.....	Routine Maintenance
20-22.....	Trouble Shooting Guide
23.....	KaiVac Accessories
24.....	Water Airflow Schematic
25.....	Wiring Diagram

## SECTION 2

1-2-3-4-5.....	Parts list
6.....	External View
7.....	Internal View
8.....	CVS12 Squeegee Tool
.....	SUBEB2001 Electrical Box
9.....	SUBGA Gun Assem.
.....	SUBFL Float Shutoff
10.....	SUBSP Standpipe
.....	Water Filters
11.....	SUBIQD Chemical Injector
.....	SUBWHR Water return / T Connect
12.....	SUBPA Pump Motor Assem
.....	Unloader Check Valve
13.....	SUBCE Carpet Extractor
.....	KAIMOP
14.....	Upholstery Tool
.....	Muffler



# ***SECTION 1***

# Introduction

## INSPECTION

Carefully unpack and inspect your new KaiVac cleaning machine for shipping damage. Each unit is tested and thoroughly inspected before shipping. For instructions regarding any shipping damage, contact KaiVac immediately. All returns must have a Return Authorization Number (RAN).

## WARNINGS

- **DO NOT** operate with a frayed, worn or damaged cord.
- **DO NOT** use to pick up flammable or combustible materials.
- **DO NOT** run the pump without water in the water tank.
- **DO NOT** use hot water.

## GROUNDING INSTRUCTIONS

THE KAI VAC MUST BE GROUNDED. If it should malfunction or stop working, grounding provides a path of least resistance for electrical current, thereby reducing the risk of electrical shock. The KaiVac is also supplied with a ground fault circuit interruptor (GFCI) to reduce danger of electric shock. It must be maintained and tested regularly. This unit is equipped with a cord that has an equipment grounding conductor and a grounding plug. The plug must be inserted in an appropriate outlet that is properly installed and grounded in accordance with all local codes and ordinances. Cutting off the ground wire or using a cord that is not equipped with a ground plug will void the warranty on the unit, and KaiVac will accept NO responsibility associated with the unit.

Improper connection of the equipment grounding connector conductor can result in a risk of electrical shock. Check with a qualified electrician or service person if you doubt the outlet is properly grounded. Do not modify the plug provided with the KaiVac. If it will not fit the outlet, have a proper outlet installed by a qualified electrician.



# Safety Precautions

- **Equipment Warning**
  - Read all instructions to ensure safe operation of the KaiVac.
- **Training**
  - Proper training is required before using the KaiVac. Contact your authorized KaiVac distributor for training information.
  - Instruction placards are attached to each KaiVac and should not be removed. These placards show proper cleaning procedures and safety precautions.
- **Equipment Use**
  - Do not use the equipment in a manner that it was not intended for by the manufacturer.
  - See S-I-M-P-L-E Operation section for proper use of the equipment.
- **Spray Gun**
  - Never point the spray gun at people.
- **Prevention of Electrocutation –**
  - Use the ground fault circuit interruptor (GFCI) with the KaiVac at all times.
  - Test the GFCI before each use.
  - Do not spray liquid from the KaiVac onto electrical outlets or on any electrical devices.
- **Personal Protection –**
  - Wear gloves, eye protection and ear protection when operating the KaiVac.
- **Prevention of Water Damage to Buildings**
  - The KaiVac is to be used on water-resistant building surfaces only. These include concrete, terrazzo, ceramic tile and quarry tile.
  - The KaiVac may be used for stripping on vinyl-composite tile floors, but daily cleaning of resilient flooring using the KaiVac is not recommended.
  - Never overflow the water tank or the vacuum recovery tank.
  - Discontinue use if any leaks occur in the KaiVac.

**CAUTION:** Prior to cleaning, always inspect area to ensure that the surfaces to be cleaned are water-safe. In addition, check for poor construction, damaged walls and floors, missing or damaged tiles or grout, missing or insufficient caulk, and loose wall coverings. If problems are discovered, resolve them prior to cleaning in order to avoid any harm that may result from exposure to water or cleaning solution.

- **Chemical Use**

- Only use chemicals approved for use with the KaiVac. Use of non-Kaivac Will reduce warranty and may cause machine damage.
- Turn Chemical line off when not in use.
- Keep the appropriate chemical MSDS sheets on hand at all times.
- Cleaning chemicals should not be put in the water tank (with the exception of KaiDri in small amounts). Cleaning chemicals in the water tank can cause operator harm and machine damage because of the following:
  - Chemicals in the water tank must pass through the pump which may cause premature pump failure. Use of chemicals in the water tank voids the warranty.
  - Chemicals in the water tank will be aerosolized and may harm the operator.

- **Electrical**

- Do not pull the KaiVac by the cord or use the cord as a handle. Do not close a door on the cord or pull the cord around sharp edges or corners. Do not run over the cord. Keep the cord away from heated surfaces.
- DO NOT pull on the cord to unplug. Grasp the plug at the outlet and pull.
- Turn off the unit before unplugging.
- Connect to a properly grounded outlet only.

- **Machine Integrity**

- Do not run the pump dry. This will void the machine warranty.
- Do not run hot water through the pump. This can cause pump cavitation and will void the warranty.
- Always be sure the water tank and water line filters are clear of debris. Running the pump with clogged filters can cause pump damage.
- Replace any damaged cords before use.
- Replace any damaged hoses before use.

**SAVE THESE INSTRUCTIONS**  
**Violation of any of these instructions may void any and all warranties**

## Limited Warranty Protection Plan

The KaiVac has been engineered and tested to provide long lasting performance. This warranty covers defects in workmanship or materials under normal use and service from the date of purchase.

Kaivac warranties the following components to be free from defects in materials and workmanship for these time periods:

**1.) KaiChem Warranty for end users who use only Kaivac chemicals for the life of the machine.**

- 10 years on rotationally molded parts.
- 3 years on other parts (excluding wear items)
- 1 year on labor

**2.) Standard Warranty (When Kaivac chemicals not used)**

- 1 year parts and labor

All Kaivac replacement parts are guaranteed for 90 days from the date of installation. Normal wear items such as wheels, hoses, seals, gaskets, cords, casters, squeegees and GFCI are excluded from warranty coverage.

All warranty claims must be accompanied by a Return Authorization Number (R.A.N.), which is available by calling the Kaivac Customer Service Department. No returns will be accepted without a R.A.N.

This warranty does not apply to return freight costs, damage or defect caused by accident, negligence, misuse, fire or repair done by anyone other than a Kaivac authorized repair center. In no event shall Kaivac, Incorporated be liable for incidental or consequential damages, or any damages to persons or property.

Please Note: Some states do not allow the exclusion or limitation of incidental or consequential damages. This warranty is in lieu of any other warranty expressed or implied, including any implied or merchantability for a particular purpose otherwise. Under no circumstances will the seller be liable for any loss, damage, expenses or consequential damages arising in connection with the use or inability to use seller's product. Kaivac, Incorporated reserves the right to make changes or improvements to its equipment without notice.



# S\*I\*M\*P\*L\*E

No-Touch Cleaning Method

## S et-up

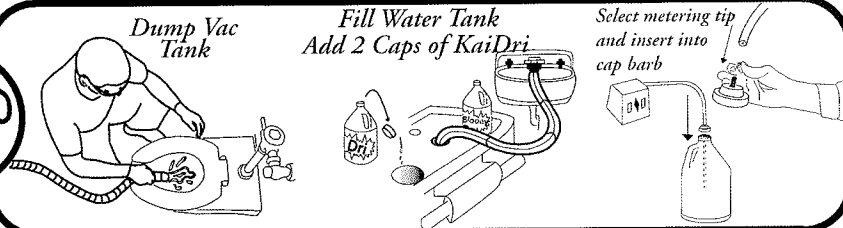

## I nject C hemicals

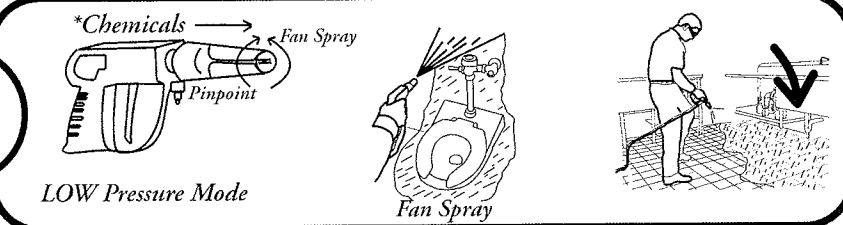
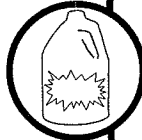

## M anual B rush (OPTIONAL)

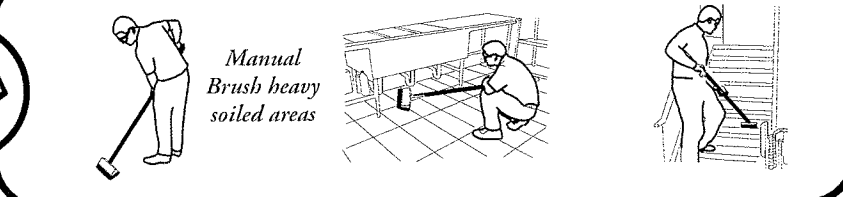

## P ressure Wash & R inse

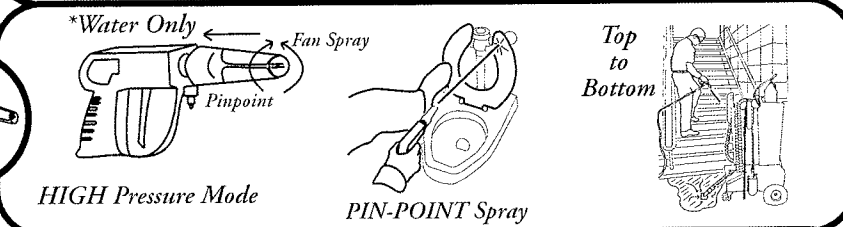
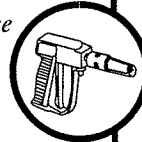

## L oop Spray L ine

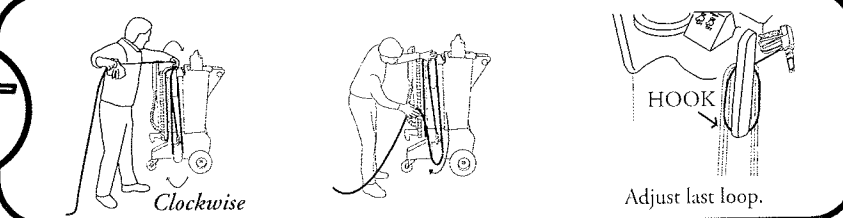
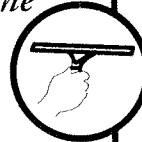

## E xtract & D ry

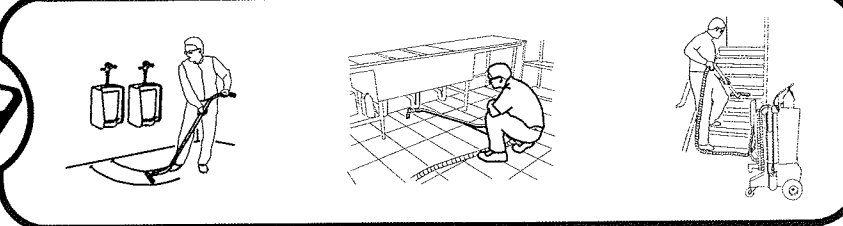

# Kaivac No-Touch Restroom Cleaning

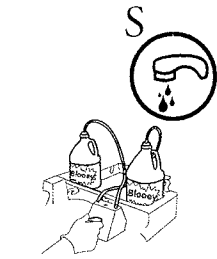

Turn valve on,  
Check tank levels,  
Optional:  
Dust with KaiHose

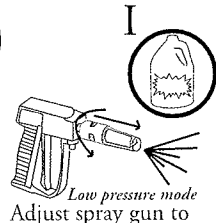

*Low pressure mode*  
Adjust spray gun to  
chemical injection,  
pull nozzle out and  
rotate to fan pattern.

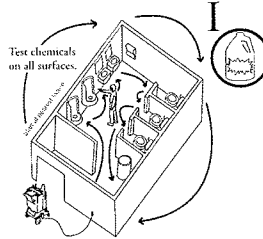

Inject chemicals on fixtures and  
soiled areas, start at the nearest  
fixture traveling in circular pattern.

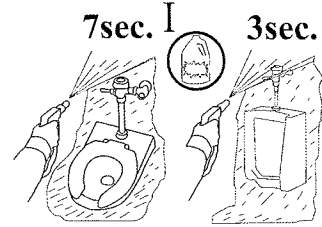

Apply cleaning  
solution to fixtures.  
Sinks 2sec.  
7sec. 3sec.

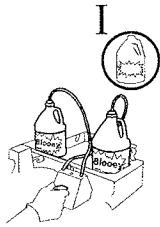

Turn  
chemical  
valve off.

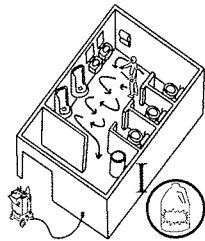

Rinse chemical  
from line onto floor.



Optional: Manual Brush  
heavily soiled floors.

Push nozzle in and rotate  
to a pinpoint pattern.

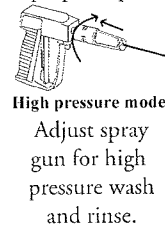

*High pressure mode*  
Adjust spray  
gun for high  
pressure wash  
and rinse.

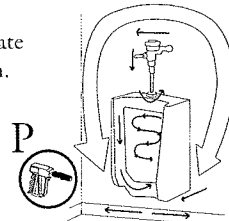

Pressure wash fixtures  
in a **top to bottom**  
pattern.  
Sinks 7sec.

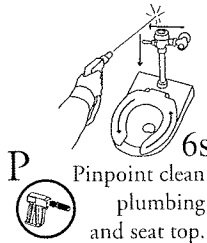

Pinpoint clean  
plumbing  
and seat top.

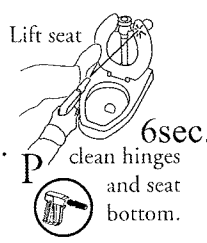

Lift seat  
clean hinges  
and seat  
bottom.



Rim Shot  
Place nozzle  
under rim  
and rotate.



Slam Dunk  
Spray  
into  
bowl.

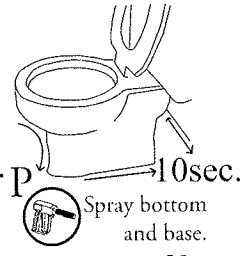

Spray bottom  
and base.

**Toilet Cleaning time 30sec.**

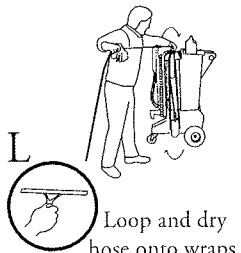

Loop and dry  
hose onto wraps.

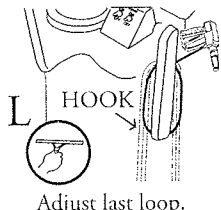

Adjust last loop.

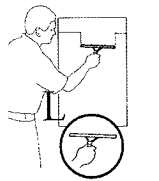

Squeegee mirrors  
and flat surfaces.



Wet vac restroom  
floor from front to rear  
*Load paper and  
supplies and  
examine.*

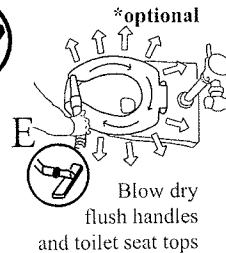

*\*optional*  
Blow dry  
flush handles  
and toilet seat tops

Restroom Cleaning

# Kaivac Kitchen Cleaning

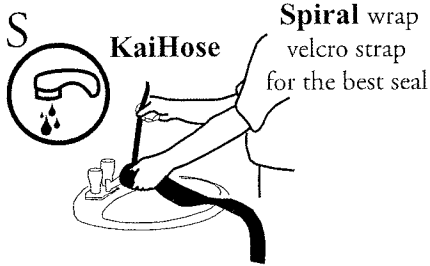

Inject chemicals on soiled surfaces and floor.

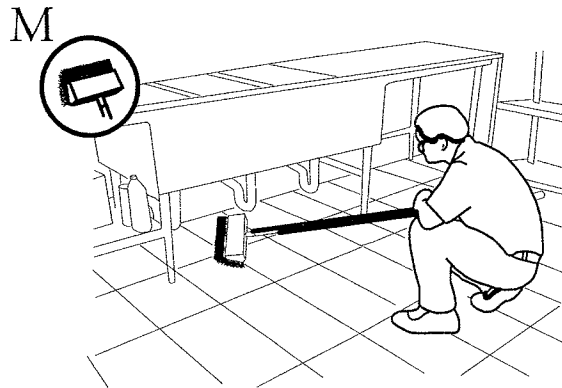

Manually brush floor in heavily soiled areas.

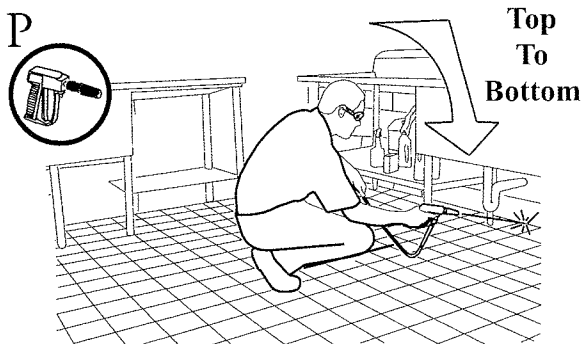

Pinpoint spray works great removing soils in corners and around base boards.

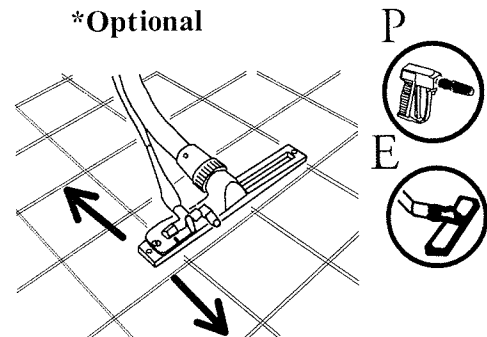

Allow degreaser proper dwell time then blast grout lines with KaiMop.

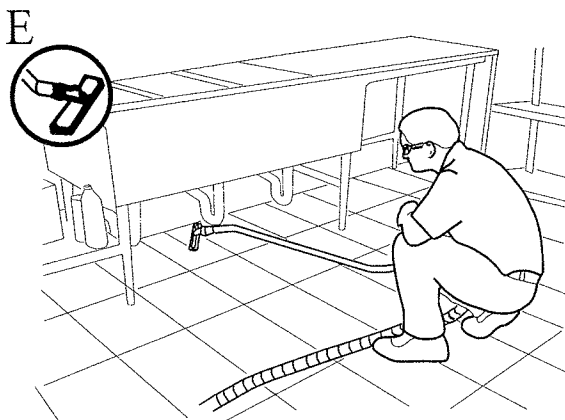

Lay Wand flat and maneuver under equipment.

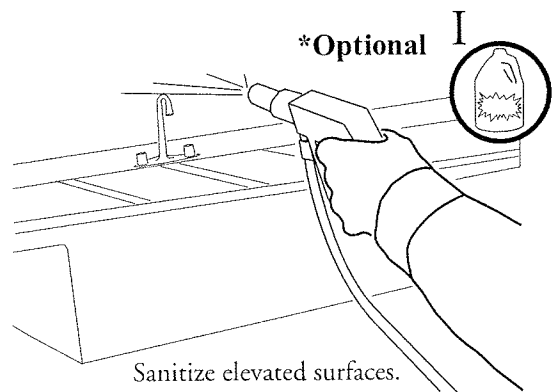

Sanitize elevated surfaces.



# SIMPLE Stairwell Cleaning



High dust cobwebs from hard to reach areas using the KaiBlower and squeegee wand

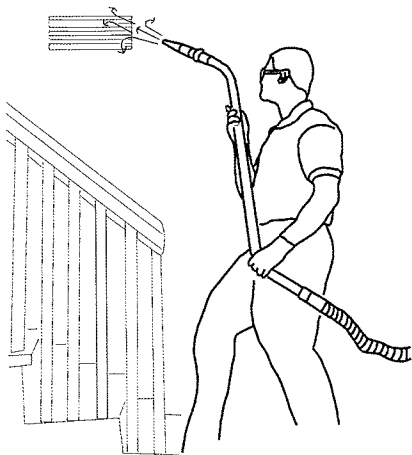

Position KaiVac at bottom of stairs with KaiDrain in position to suction excess moisture. Inject chemicals and apply to walls & stairs

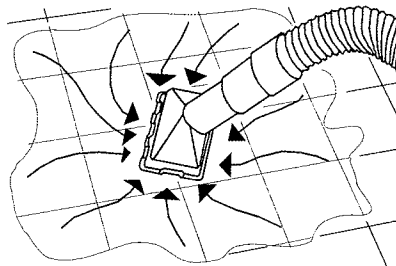

KaiDrain is an instant drain if puddling occurs

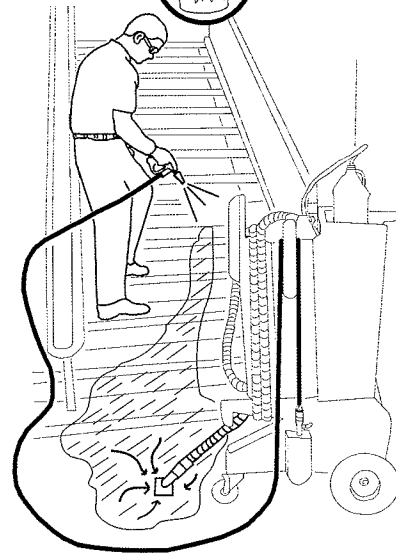

M



\*OPTIONAL

KaiBrush walls & stairs for heavy soils.

Use the KaiGrouter or KaiMop (if available) to better control water

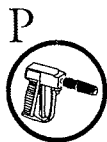
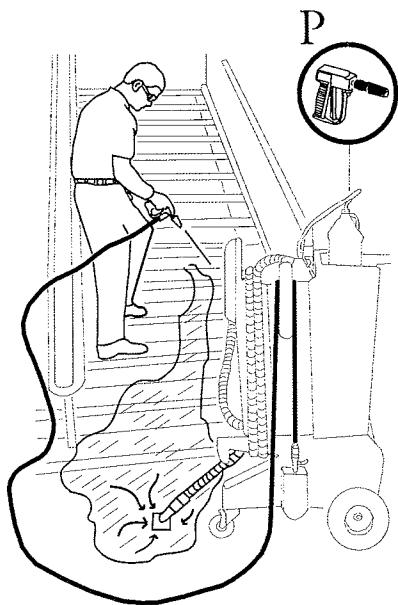

\*OPTIONAL

The floor squeegee tool sucks away soils and solution leaving stairway sparkling clean. Soils are contained in the KaiVac for later disposal

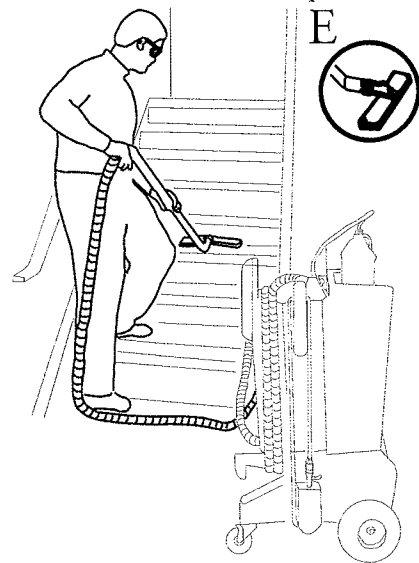

Stairwell Cleaning

# Kaivac

## KaiTricks Power Prime 2001 Model

(SERIAL NUMBER 3000 AND HIGHER)

**NOTE:** Power priming is required if the water tank has been run dry and the pump will not automatically self prime. Perform all six steps.

### Fill Tank

1

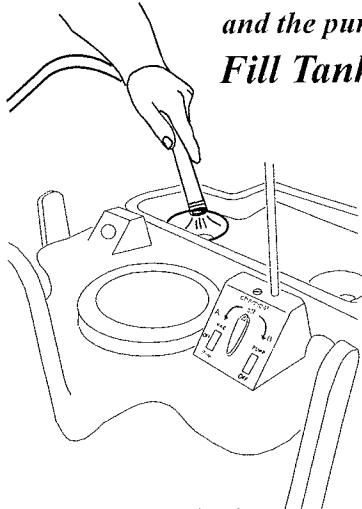

Fill water tank completely.

### Turn Chemical Off

2

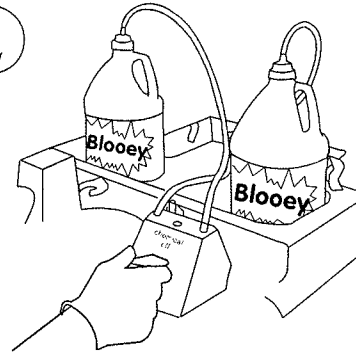

Turn chemical selector to the off position.

3

### Disconnect Spray line

Disconnect the spray line at base of machine.

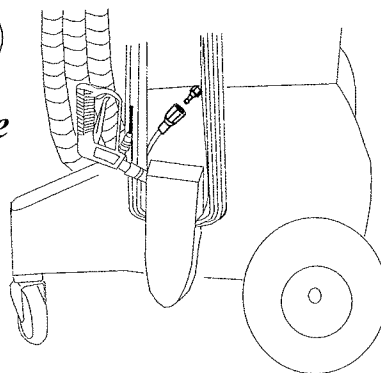

4

### Attach Nozzle

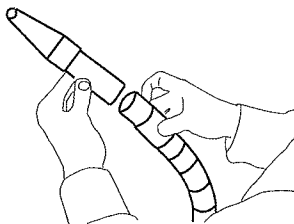

Connect the nozzle to the end of the vac hose.

5

### Vacuum Pressure Line

Firmly press the vac nozzle over the pressure line fitting coming out of the base of the machine. (turn on vac and pump motor and wait for prime) Prime should occur within 1 minute.

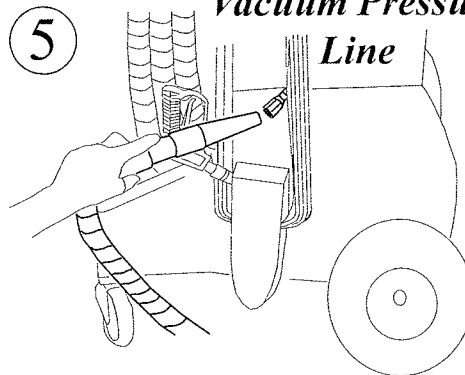

6

### Jog (Burp) the pump

Continue step 5 and jog the pump motor on and off every 3 seconds, allowing the pump to come to rest each time.

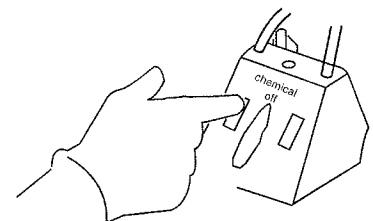

KaiTricks C



# Kaivac

## KaiTricks

### POWER PRIME (SERIAL NUMBERS 3000 AND LESS)

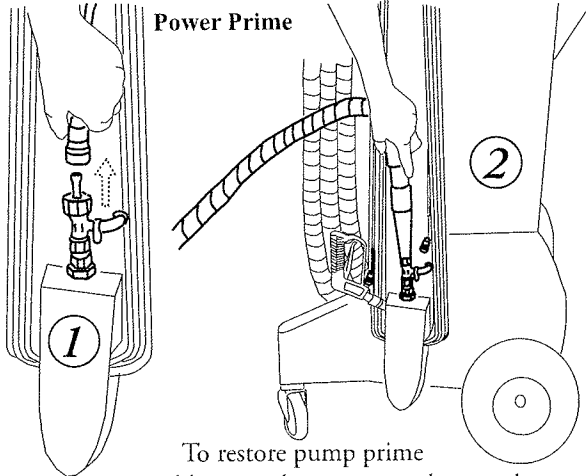

**Power Prime**

To restore pump prime connect blow nozzle on vacuum hose and place over injector. Hold in place until priming occurs. Reconnect spray line.

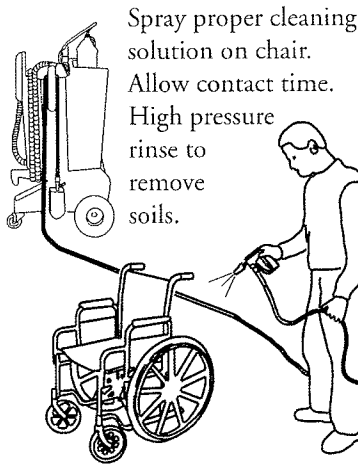

Spray proper cleaning solution on chair. Allow contact time. High pressure rinse to remove soils.

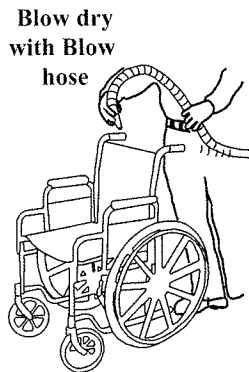

**Blow dry with Blow hose**



**Dump KaiVac at any Toilet.**

Refill the KaiVac at almost any type of sink with the KaiHose.

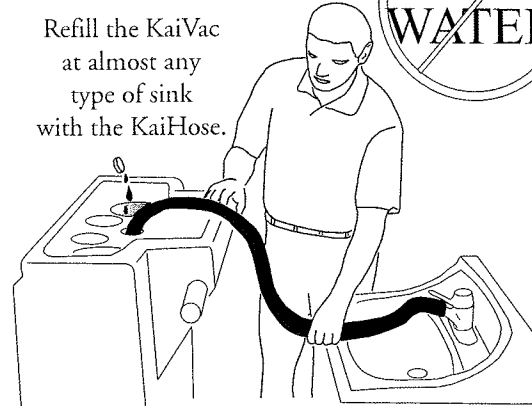

**Spiral wrap velcro strap for the best seal**



**KaiHose**

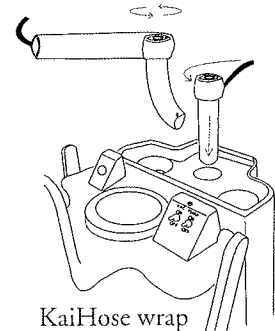

**KaiHose wrap and stow**

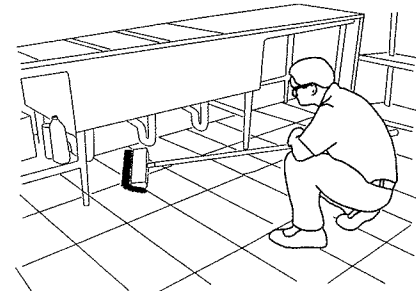

Use the KaiBrush to agitate heavy soils.

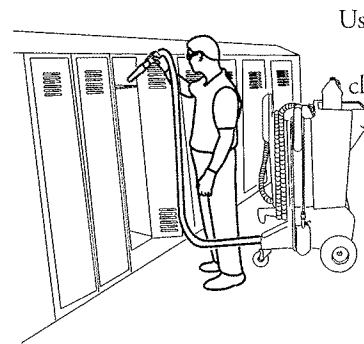

Use KaiBlower for dusting and cleaning lockers.

KaiTricks B

# Kaivac

## KaiTricks

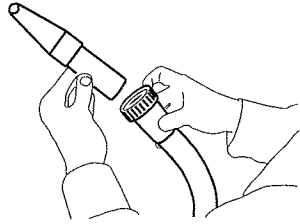

Insert KaiNozzle to blow-dust elevated areas.

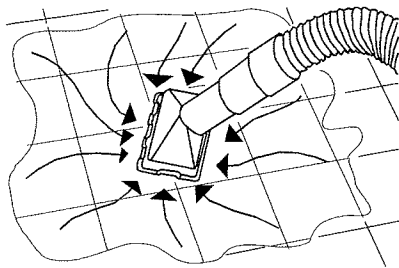

KaiDrain is an instant drain if puddling occurs.

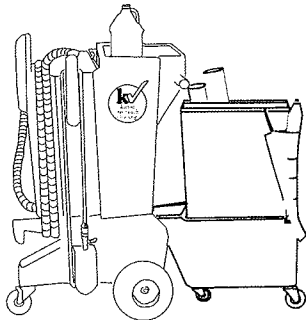

The KaiDolly carries everything you need to get the job done.

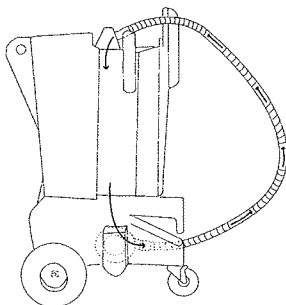

Dry vac hose by connecting hose ends to vac motor, then discharge air into vac tank.

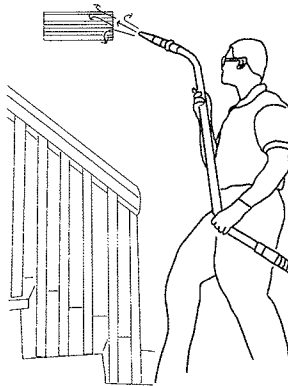

High-dust cobwebs from hard to reach areas using KaiBlower and squeegee wand

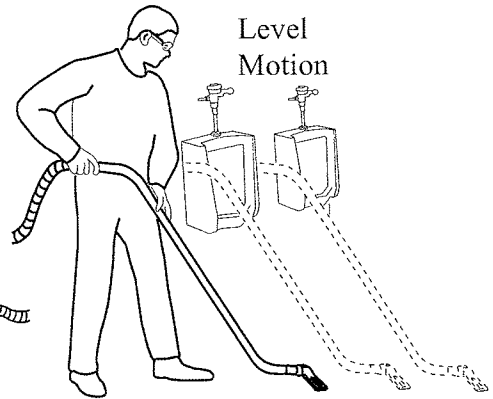

Floor squeegee works best with a level back and forward motion. Suction sound at the squeegee produces best pickups.

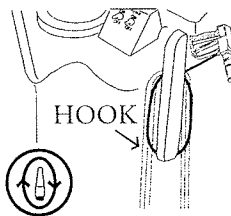

Adjust last loop.

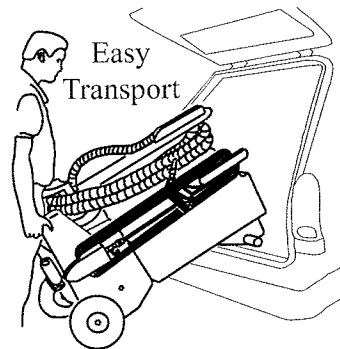

Remove Placards, Tools, Chemicals and empty tanks before loading.



Upholstery Tool works great.

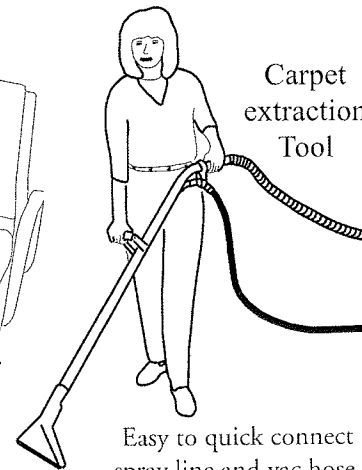

Easy to quick connect spray line and vac hose.

KaiTricks A

# Kaivac

## Tank and Hose Cleaning

1. Unwrap vac hose and lay it on floor.
2. Suck water and air from water tank. Lower hose end to surface of water gulping both air and water. This action flushes soils from line and quickly empties water tank.

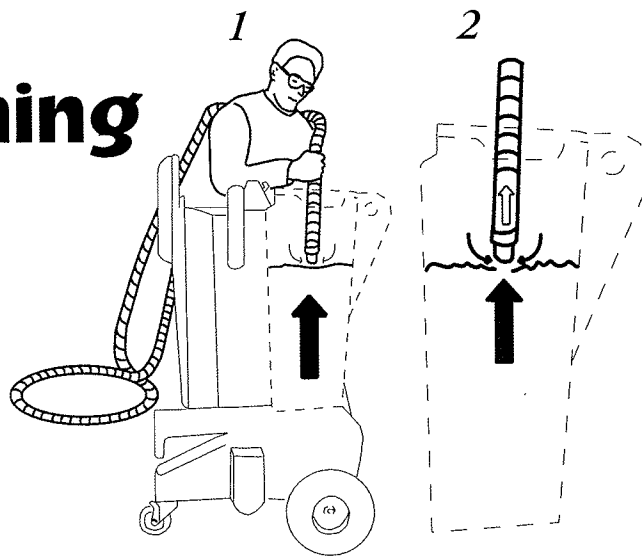

*\*Dry vac hose by connecting hose ends to vac motor, then discharge air into vac tank*

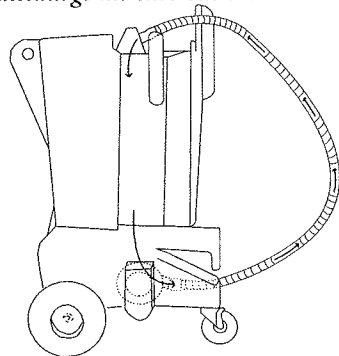

3. Vac hose can now be wrapped onto machine. Leave vac motor running while wrapping to avoid water dripping from end of hose. To completely dry hose leave vac motor running for about 3 minutes.
4. With Dump Hose opened to floor drain, spray inside of vac tank with clean water moving hose in a circular pattern to insure tank walls and float shutoff are rinsed.

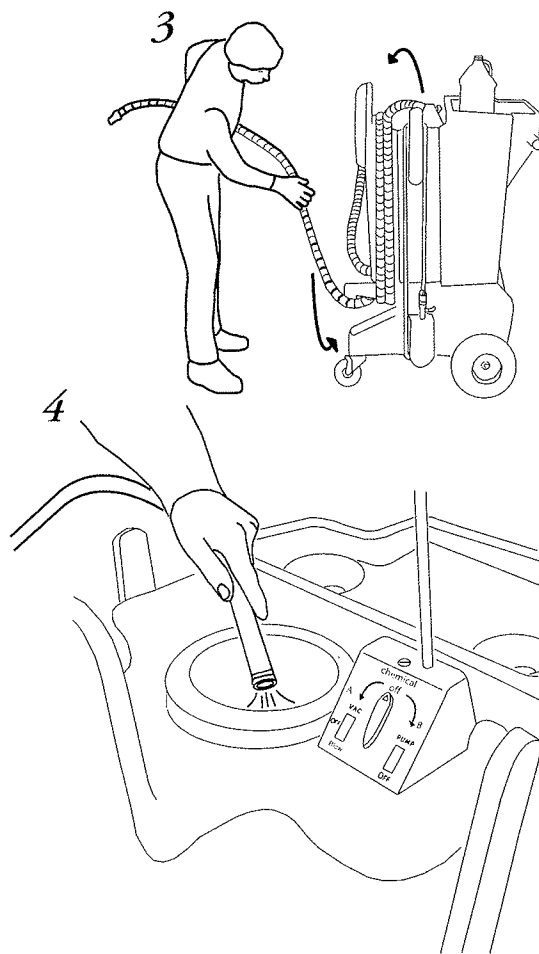

Tank and Hose Cleaning

# Kaivac General Maintenance

**Inspect Filters for dirt.**

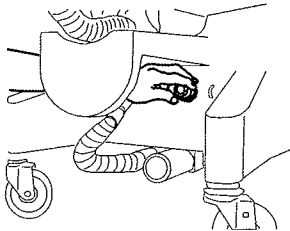

If found, remove cover, clean filter screen and reinstall.

**Inspect Muffler for soils.**

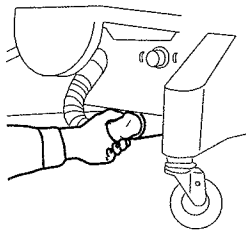

If found, remove stuffing, wash and reinstall.

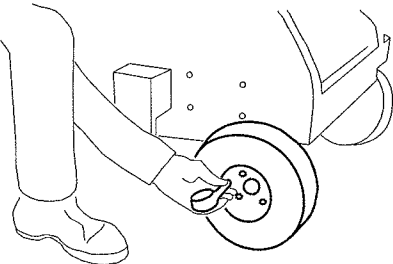

Keep tire pressure at 30 psi.

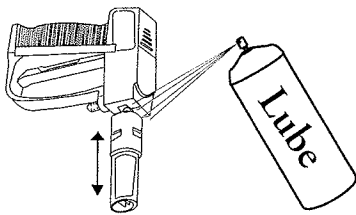

(weekly) Lubricate nozzle with penetration oil. Nozzle must move freely forward and backwards.

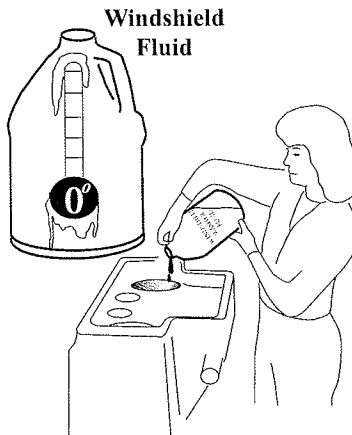

**Windshield Fluid**

Winterize KaiVac for outdoor storage or transport in sub freezing temperatures. Remove all water from tank, add 1/2 gallon windshield washer fluid. Run pump and spray until fluid is discharged from gun.

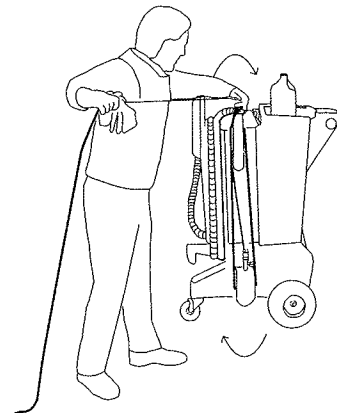

Wrap hoses and cords in a **Clockwise** direction and use a cleaning rag in one hand to wipe & dry.

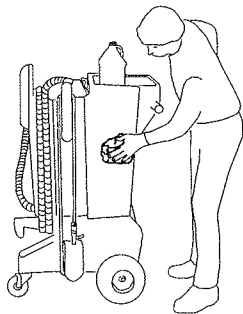

Wipe entire unit clean with an all purpose cleaner. **(DO NOT PRESSURE WASH MACHINE)**

**Unscrew locking collar to remove tools**

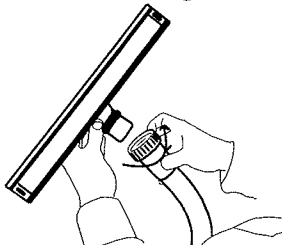

For Floor Squeegee, insure brass ring is located in groove.

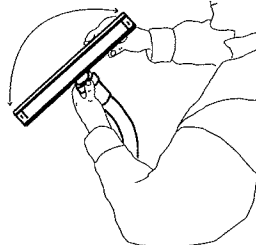

When collar is snug Floor Squeegee should rotate freely.

**Floor Squeegee**

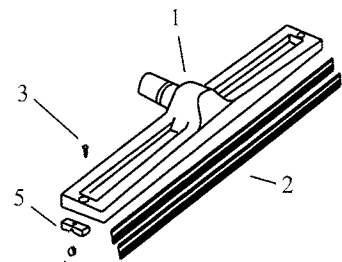
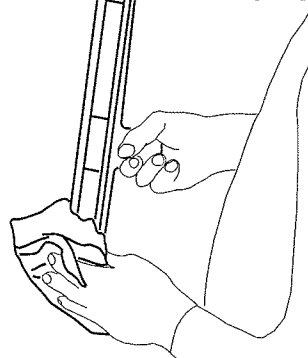

1. Squeegee Head
2. Blades
3. Screw
4. Wheel
5. Wheel Holder

Wipe Squeegee blades with cloth. Inspect tool for worn wheels and blades. Replace as needed.

General Maintenance

# Kaivac Safety

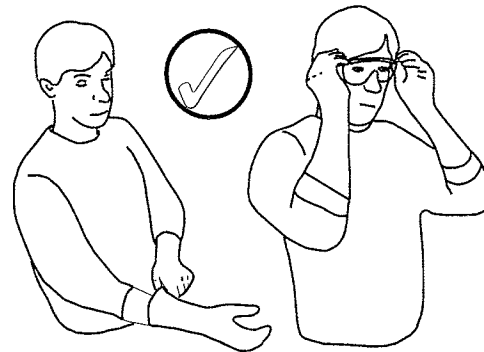
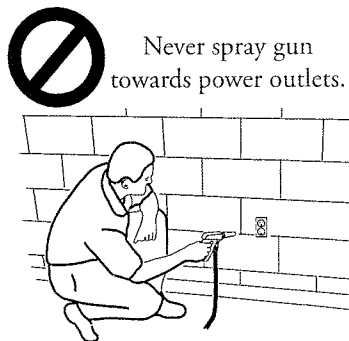
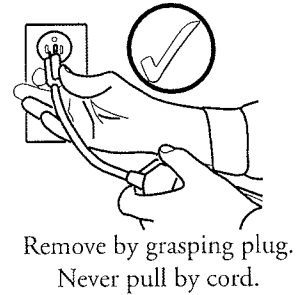
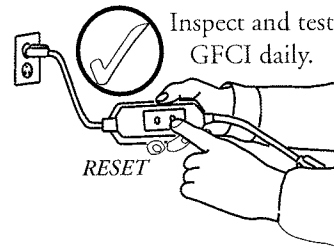
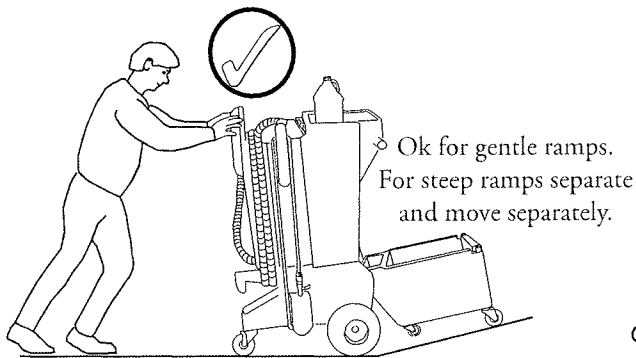
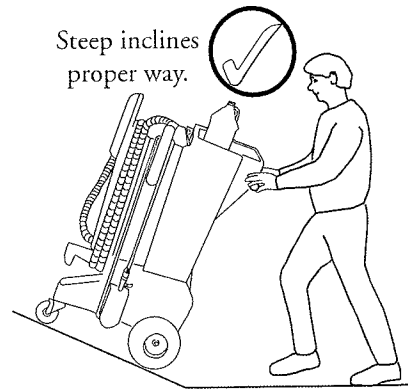

KaiVac Safety

# Kaivac

## Tool Arrangement

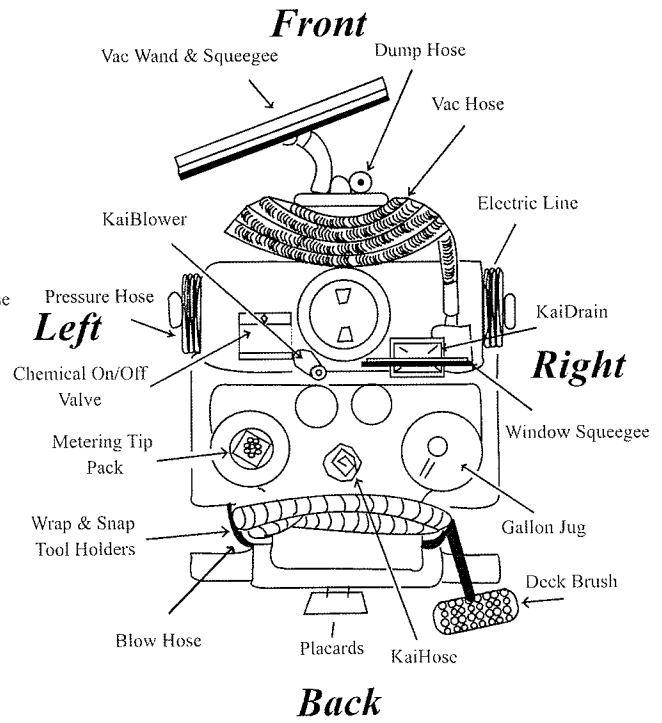
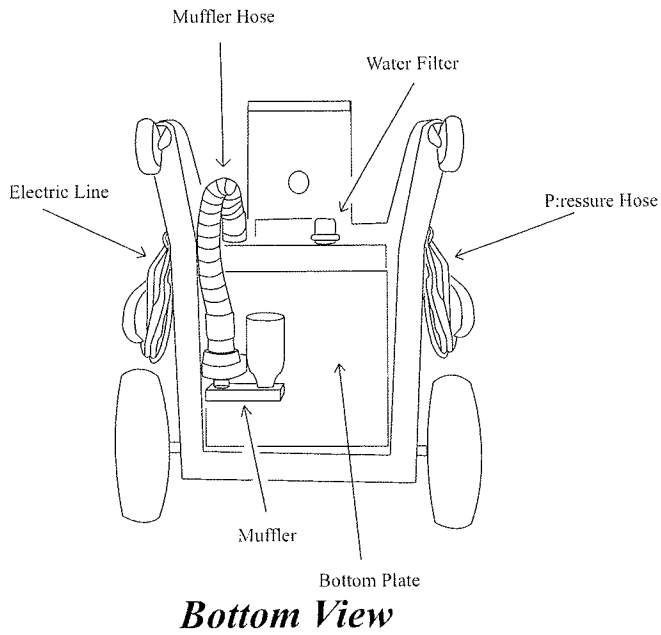
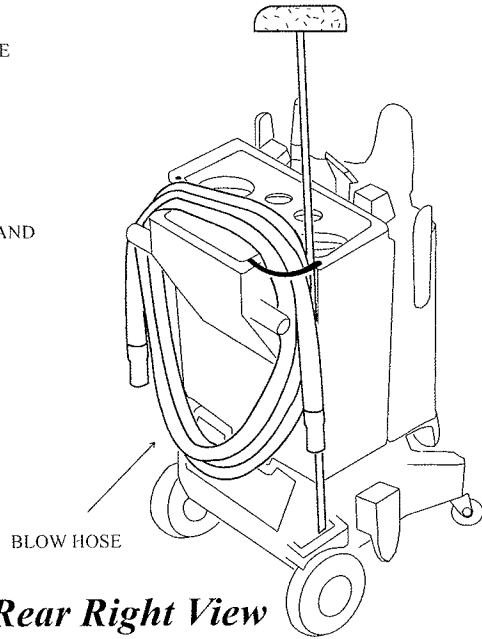
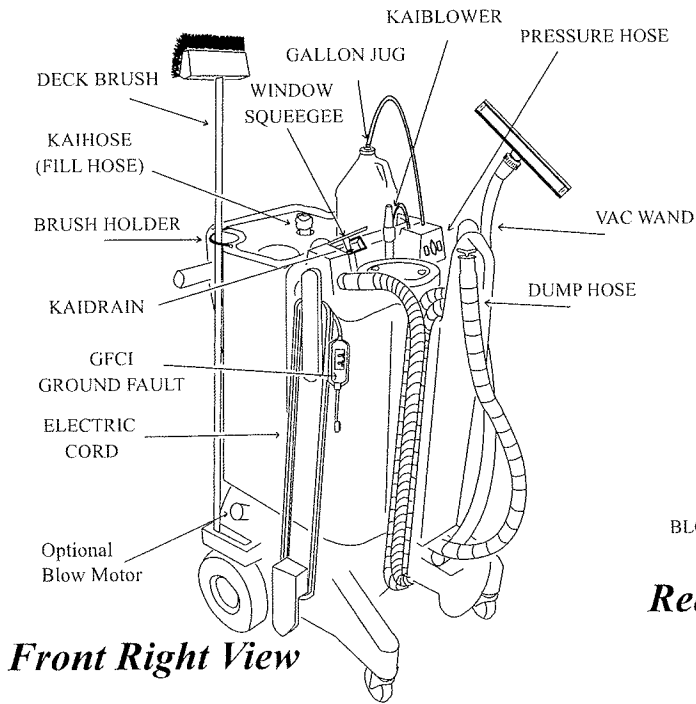

Tool Arrangement

# Kaivac Blow Operation

## Using Vac Hose (Must Clean & Dry Before Use)

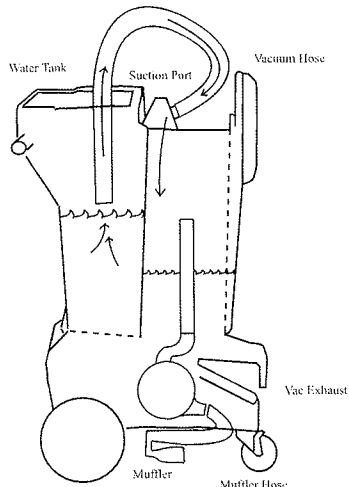

Flush (clean) Vac Hose  
Operator inserts hose into water tank for 2-3 seconds

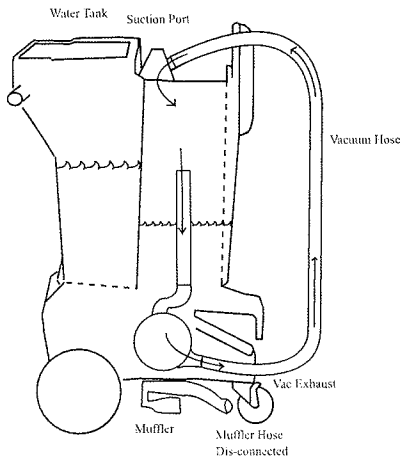

Rinse & Dry out Vac Hose  
Operator disconnects muffler hose and connects vac hose to vac motor exhaust, running motor for 3 minutes. Operator disconnects hose at vac suction port and ready for blow operation.

**OPTIONAL STEP if blow dry is required**

## Using Blow Hose

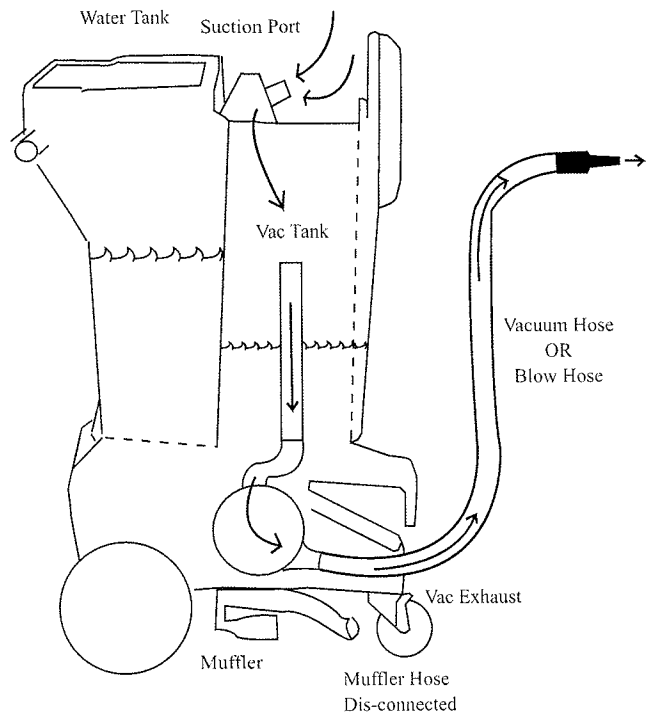

## Blow Mode

**NOTE-** Worker should wear respirator mask for Blow Operation in dusty areas.

